

High pressure at FAME _(BM30) and FAME-UHD _(BM16) beamlines

D. Testemale
French CRG



HP school at ESRF

June 17-21 2019

Outline

- FAME and FAME-UHD beamlines
- Autoclaves
- EBS



FAME and FAME-UHD beamlines



French **A**bsorption spectroscopy beamline in **M**aterial and **E**nvironmental sciences (BM30)

- X-ray Absorption Spectroscopy : speciation
- 4.8-40 keV – 100*200 μm V*H
- Concentration : >20ppm (organic) ; >200ppm (mineral)
- Solid state Canberra Ge detector

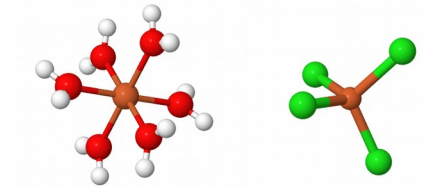

FAME and FAME-UHD beamlines



Environmental and Earth Sciences samples:

- Low concentration
 - Contain many elements
- strong S/N limitations for XAS

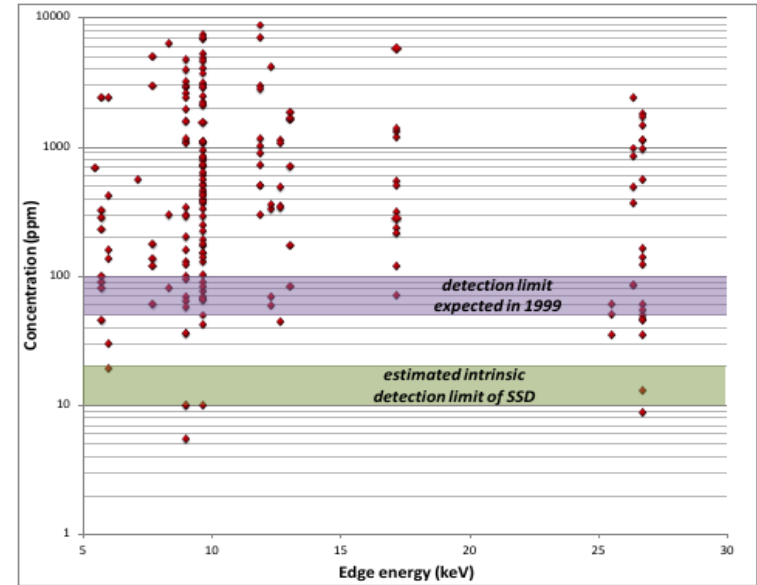

FAME and FAME-UHD beamlines

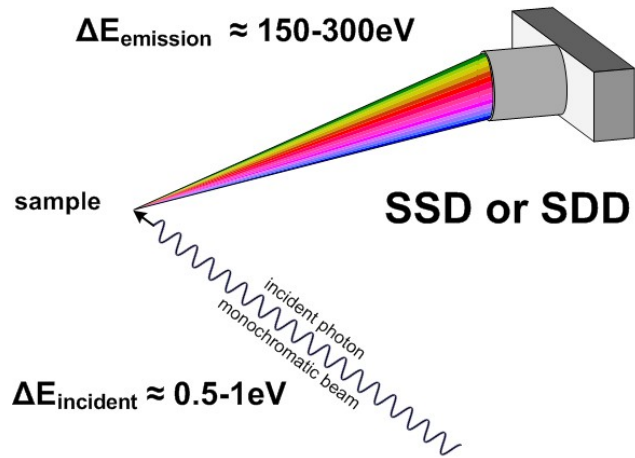

FAME and FAME-UHD beamlines

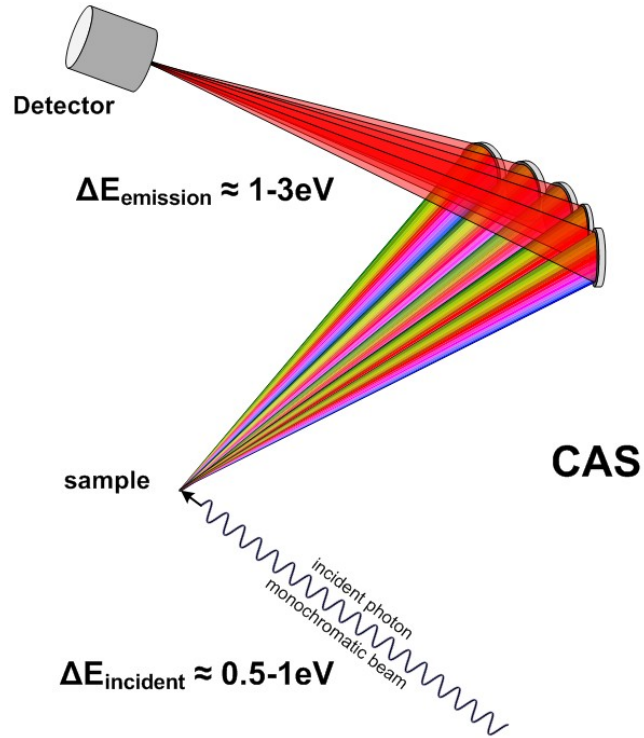
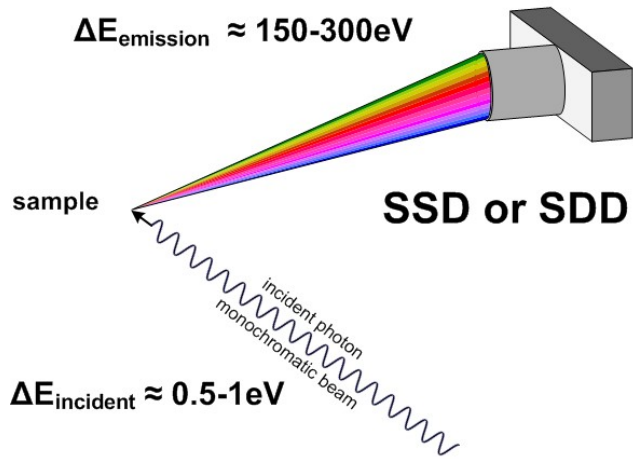

FAME and FAME-UHD beamlines



Co (layers) / Fe₂O₃ (substrate)

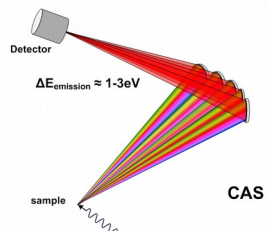
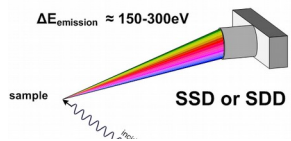
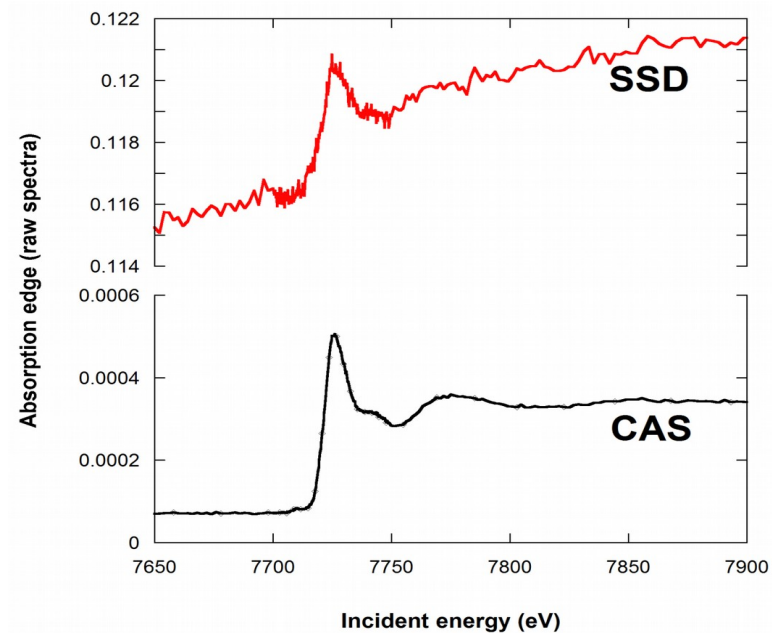
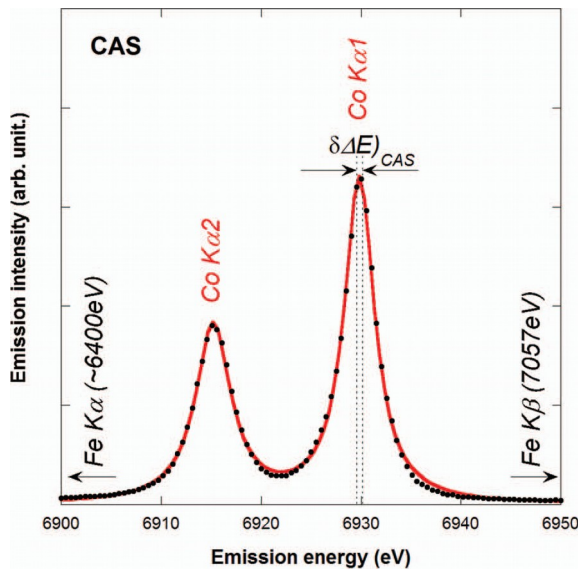
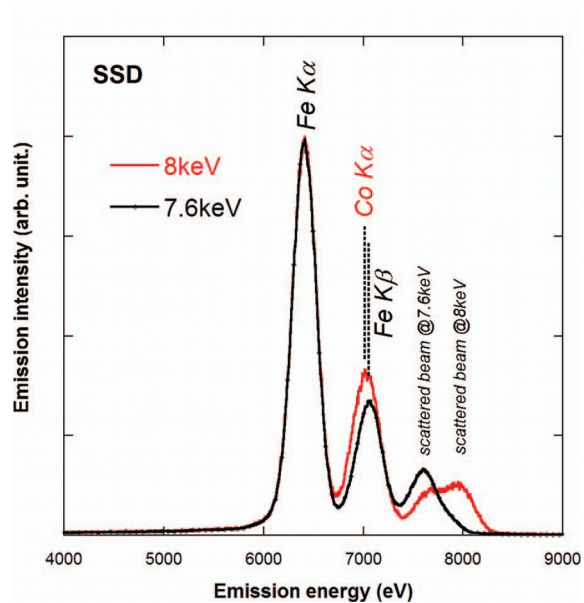

FAME and FAME-UHD beamlines

FAME
UHD

French **A**bsorption spectroscopy beamline in **M**aterial and **E**nvironmental sciences – **U**ltra **H**igh **D**ilution (BM16)

- X-ray Absorption Spectroscopy : speciation
- 4.8-20 keV - 100*200 μm V*H
- Concentration : >0.5 ppm
- Crystal Analyzer spectrometer

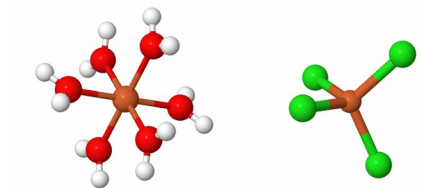

Hazemann et al., J. Synchr. Rad. (2009)
Llorens et al., Rev. Sci. Instrum (2012)
Proux et al., J. Env. Quality (2017)

FAME and FAME-UHD beamlines



French **A**bsorption spectroscopy beamline in **M**aterial and **E**nvironmental sciences – **U**ltra **H**igh **D**ilution (BM16)

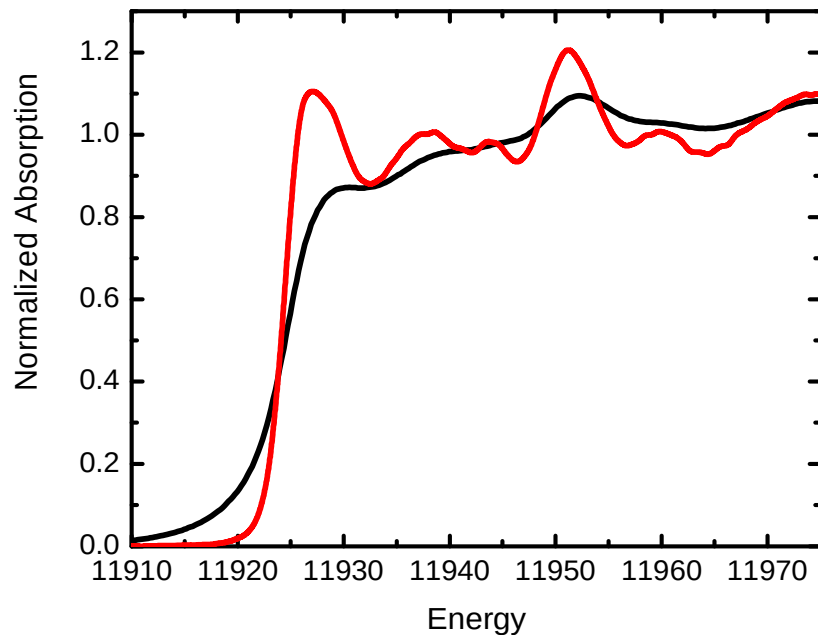

Au L3-edge, G. Pokrovski (CNRS)

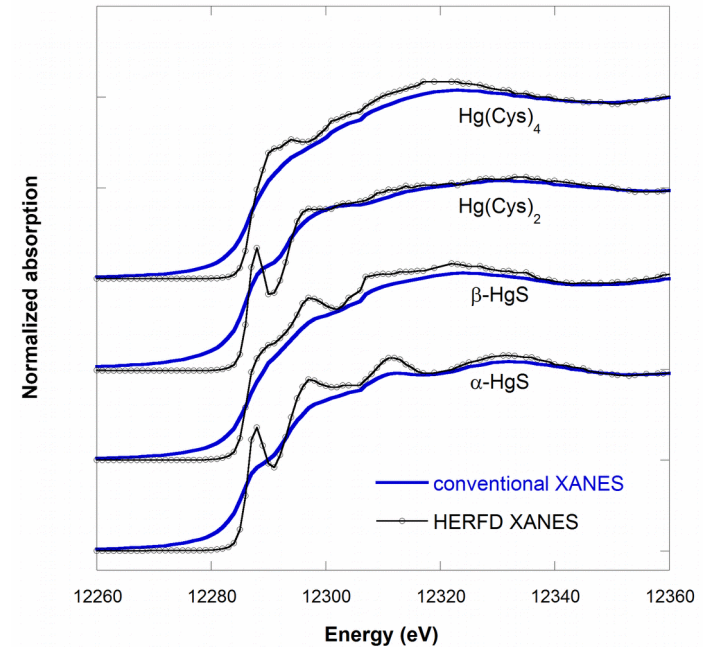

Hg L3-edge, JF Gaillard (Northwestern Uni.)

Outline

- FAME and FAME-UHD beamlines
- Autoclaves
- EBS

Autoclaves

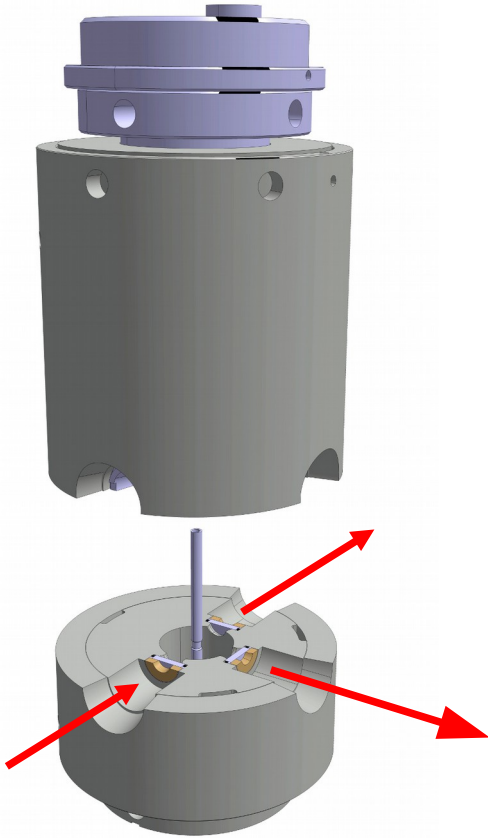

- [1-2000 bar]
[30-800°C]
- [gas-liquid-solid] densities
- 'macro' (ml) volume
- Multi-techniques
- Home-made

Testemale et al., Rev. Sci. Instrum. (2005)
Bruyère et al., J. Phys.: Conf. Series (2008)
Testemale et al., Rev. Sci. Instrum. (2016)

Autoclaves

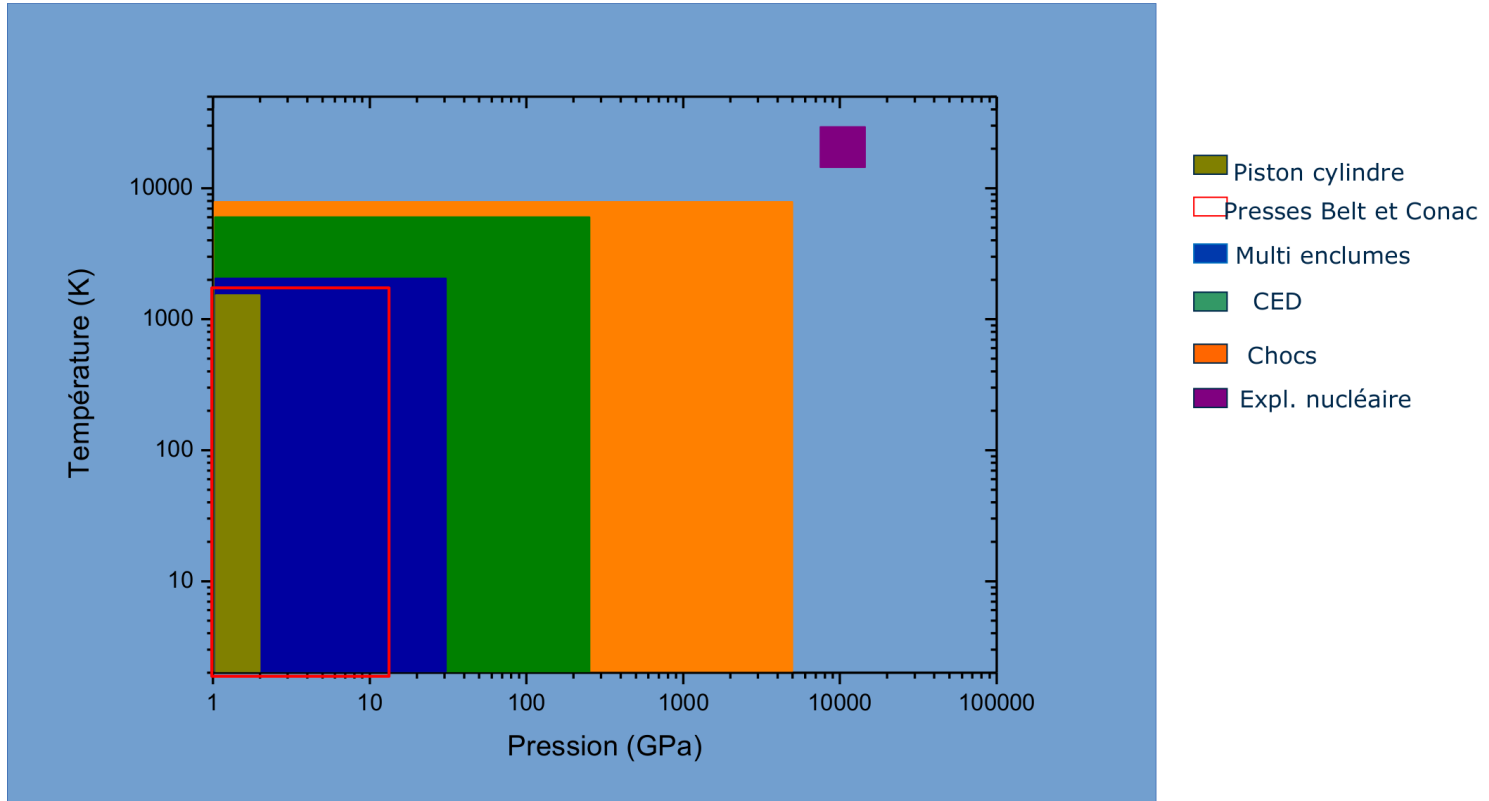

Autoclaves

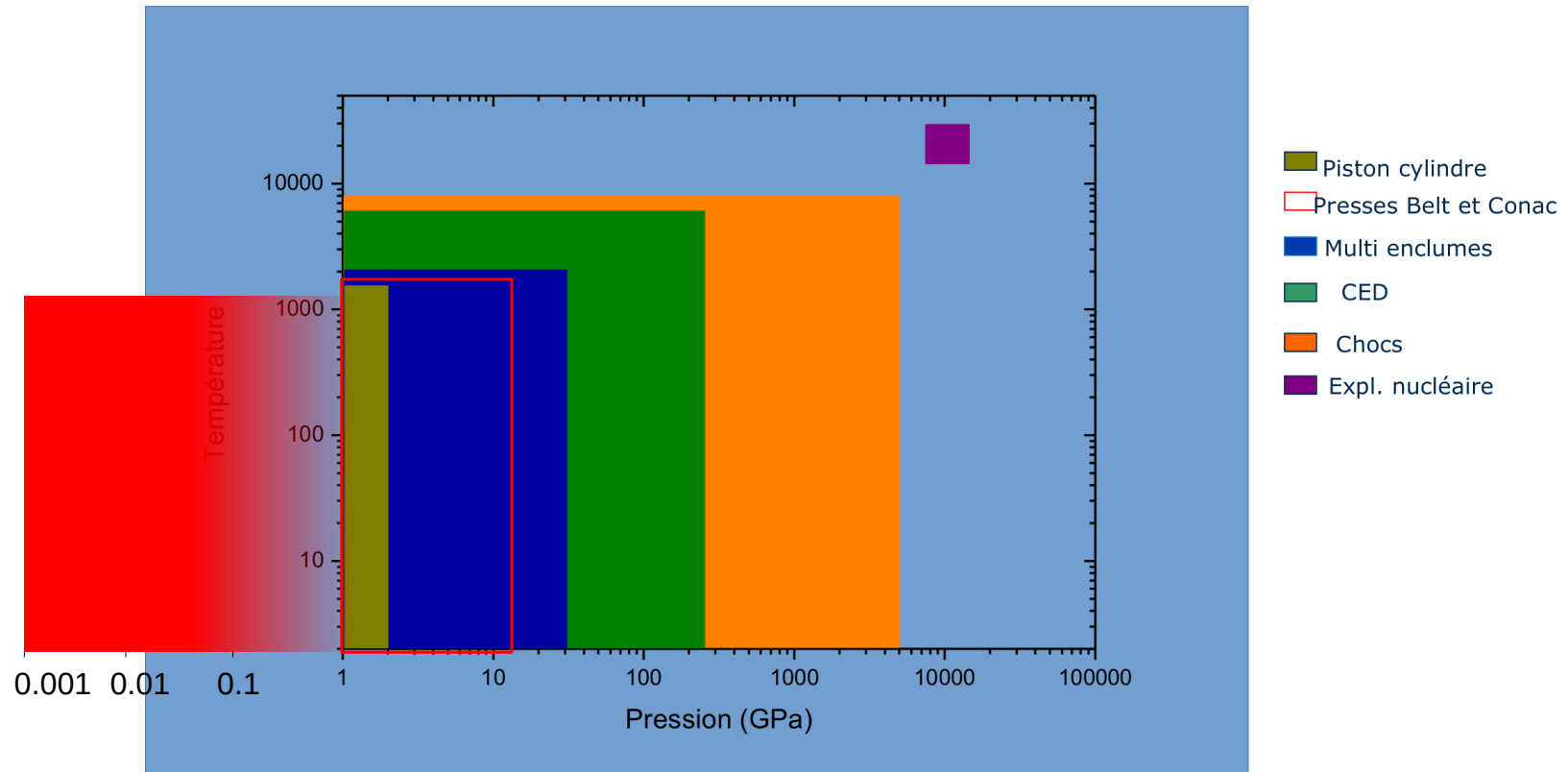

Autoclaves for spectroscopy of fluids

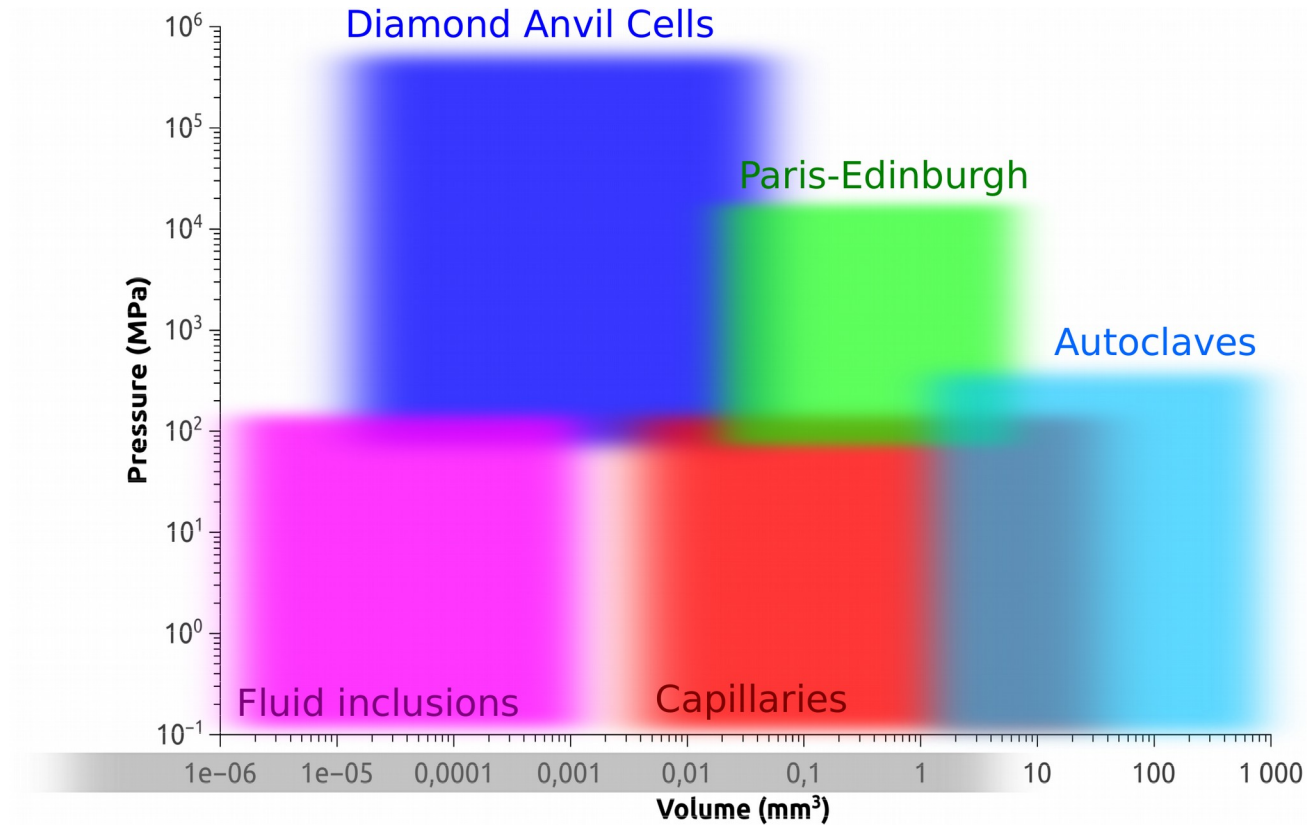

D. Testemale, J. Brugger, *Int. Tables for Crystallography: Volume I, X-ray Absorption Spectroscopy and Related Techniques*; Cells for spectroscopy of fluids at elevated pressure and temperature

Autoclaves for spectroscopy of fluids

Large sample volume :

- Loading and **recovery** of samples
- **Beam damage** on fluids :
 - radiolytic species
 - sample vol./beam vol. ratio
 - uncontrolled **redox**
 - key aspect of speciation studies

Autoclaves @ FAME and FAME-UHD

- Smooth **integration** on the beamlines (routine)
- Low concentrations (**> 50 ppm**)
- Very good data quality (fluids at HT !)
- Optimization of materials
- Very stable control of T and P ($\pm 0.05^\circ\text{C}$; ± 0.3 bar)

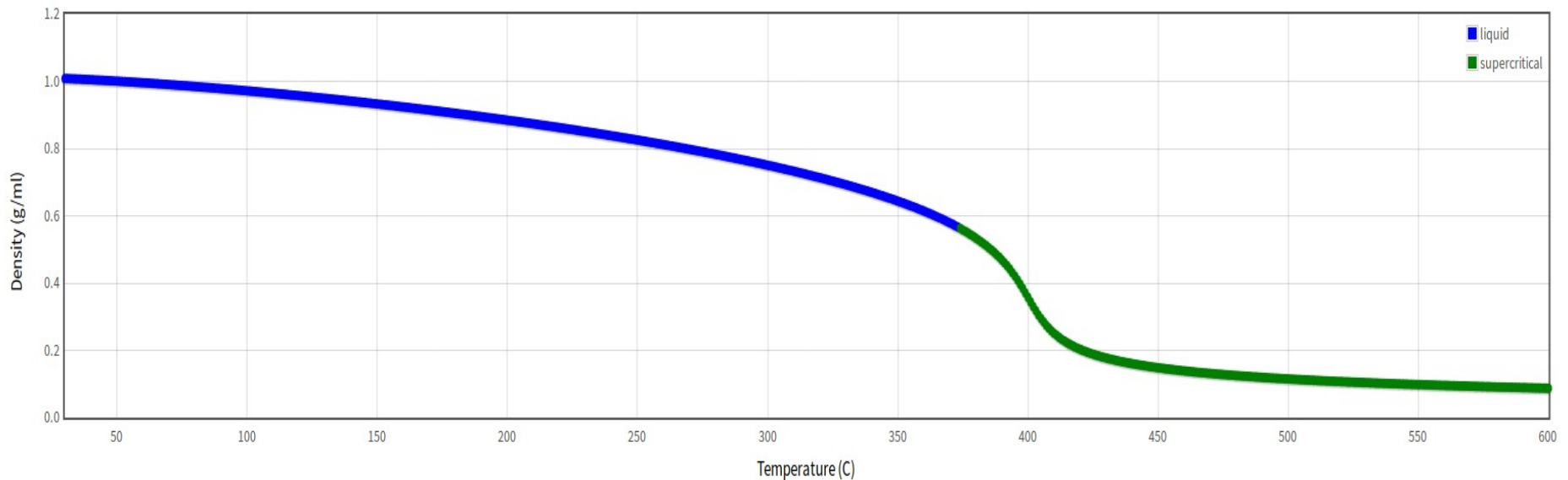

Autoclaves @ FAME - Examples

- See G. Pokrovski and M. Louvel talks.

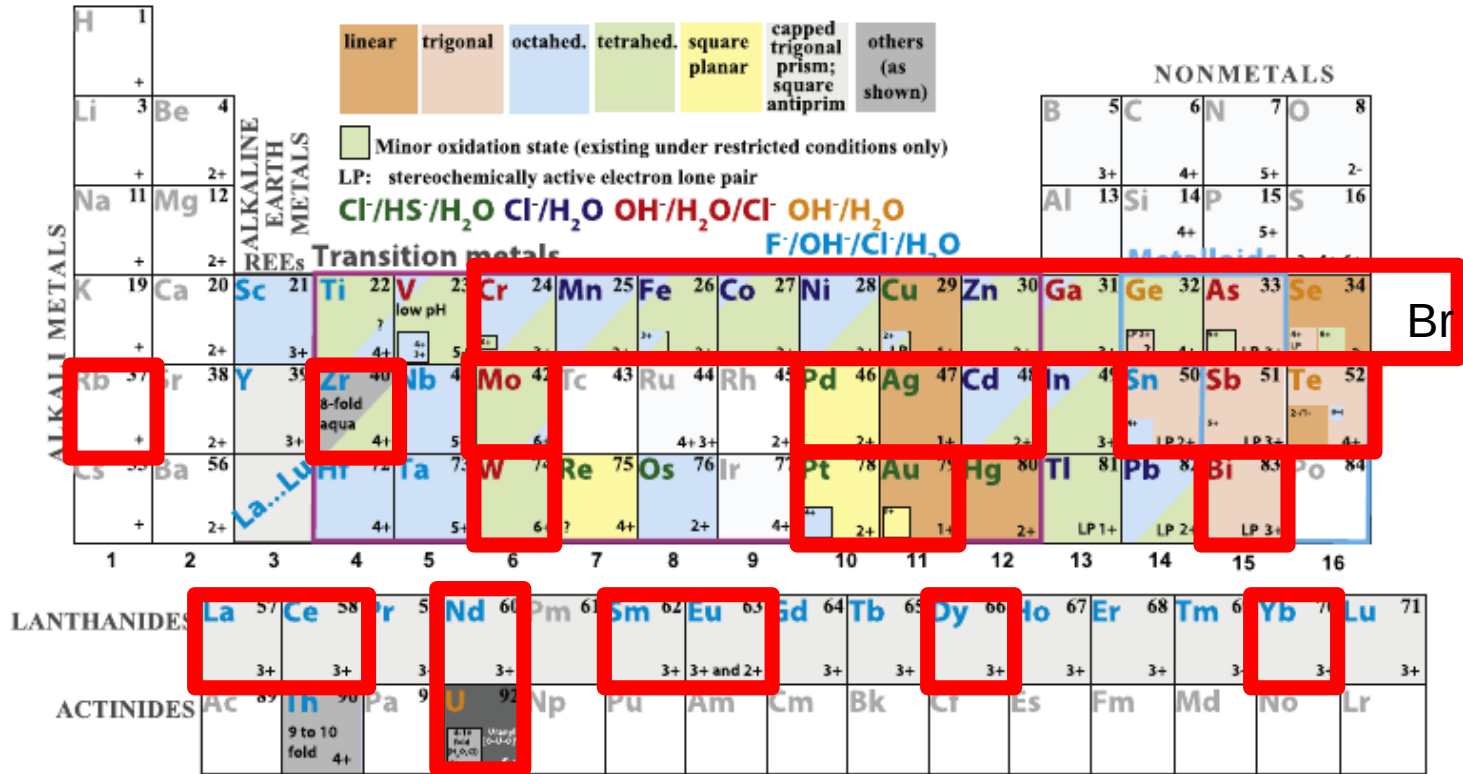

Autoclaves @ FAME-UHD - Examples

Nano YAG:Ce for LED applications

- Hydrothermal synthesis
- **In situ** HERFD XANES (200 bar ; 400°C)
- Redox of cerium ?

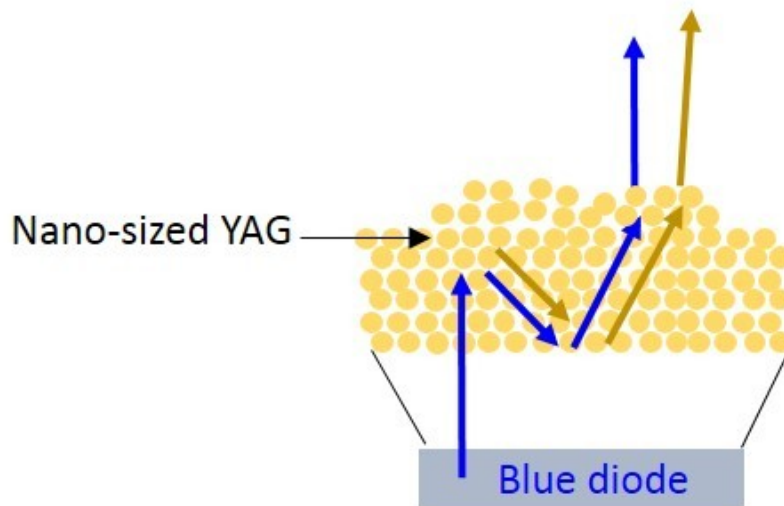
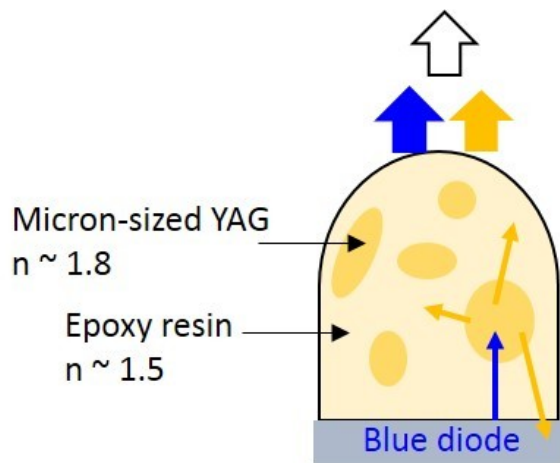

Results – Ce redox during synthesis

In situ (HERFD) XAS measurements : monitoring of redox $\text{Ce}^{3+} \rightarrow \text{Ce}^{4+}$

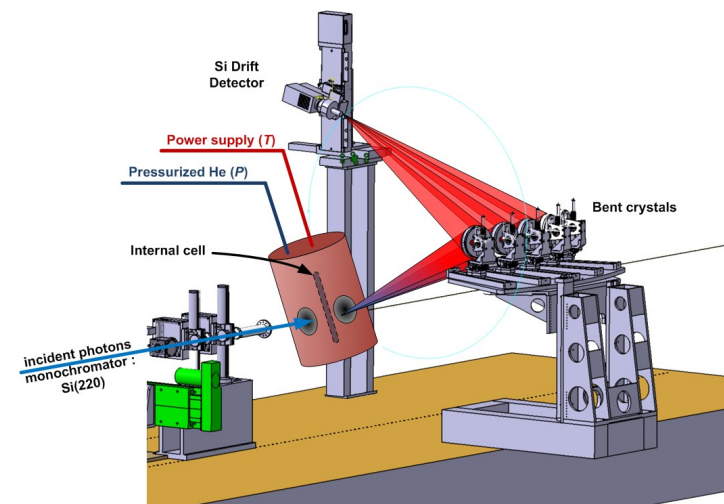
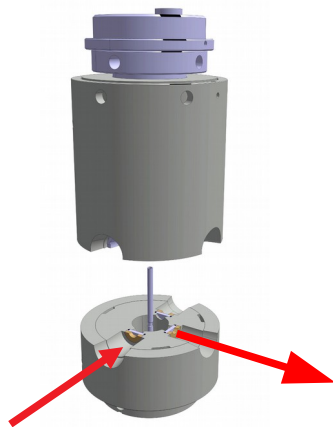
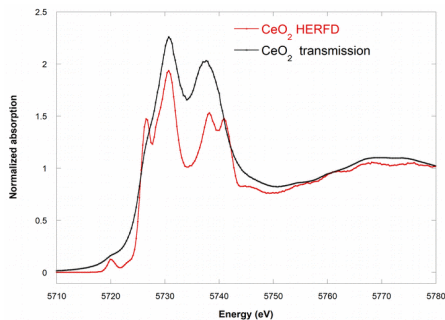

Experimental challenges :

- Low concentrations (1 % Ce in suspended nanos)
- In situ HP/HT sample environment
- Low X-rays energy (5.7 keV)
- Post mortem sample recovery

Autoclaves @ FAME-UHD - Examples

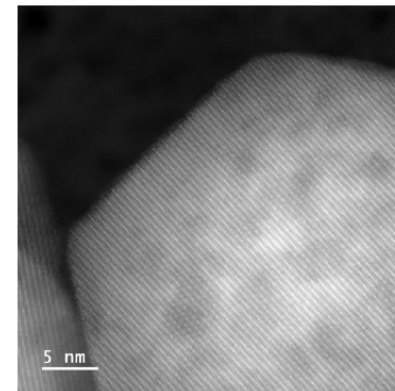
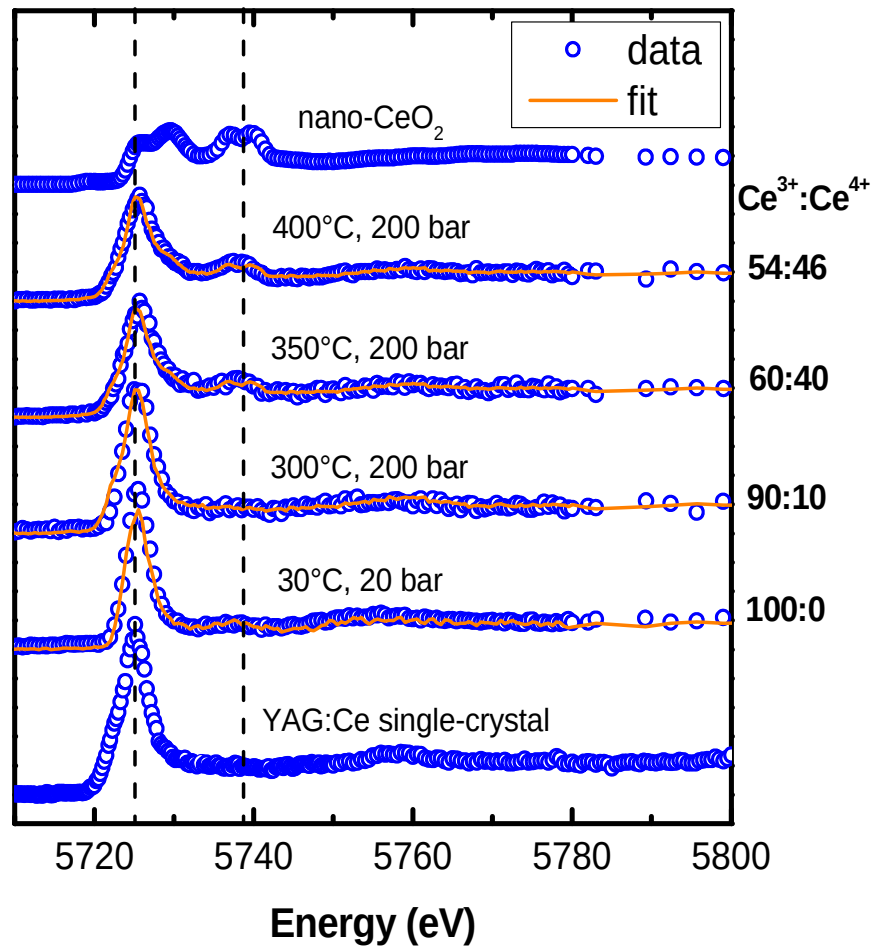

Outline

- FAME and FAME-UHD beamlines
- Autoclaves
- EBS

Environmental and Earth Sciences samples:

- **Low** concentration
- Contain **many elements**
- **Inhomogeneous** or small

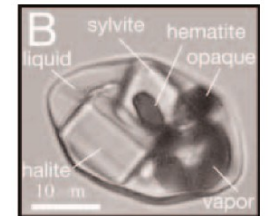
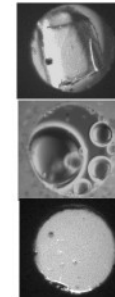
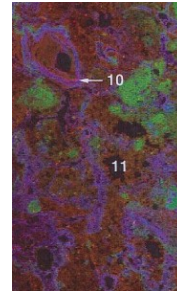

Study of **real/natural** samples :

- **Diluted** samples :
 - >10 ppm on FAME
 - >0.1 ppm on FAME-UHD
- **Inhomogeneous** samples :
 - ~ $30 \times 30 \mu\text{m}^2$ on FAME or $1 \times 1 \mu\text{m}^2$ (KB)
 - ~ $30 \times 30 \mu\text{m}^2$ on FAME-UHD
- Facilitation of **In situ, In operando** measurements

Thank you !