

ID30B – A new high intensity, tunable and variable focus MX beamline coming soon...

Andrew McCarthy (EMBL-Grenoble)

Christoph Müller-Dieckmann (ESRF)

ID30B – Opens early 2015 with SC3

MD2s – Nov 2014

Beamline
commissioning

1Q 2015

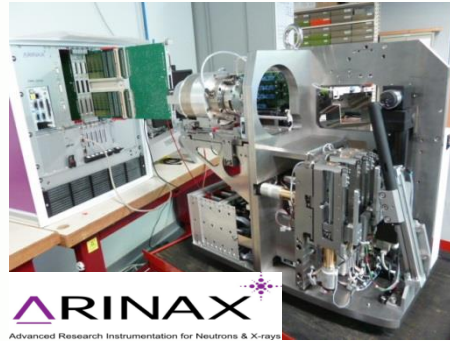

First FlexCD
users

3Q 2015

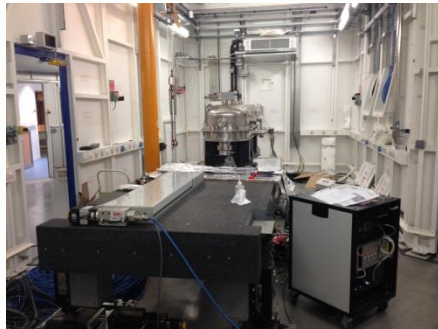

ID30B EH3

ID30B opens
(with SC3)

2Q 2015

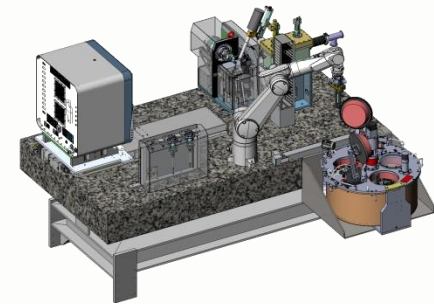

ID30B – FlexCD sample changer (3Q 2014)

MD2s goniometer

Flipping SPINE gripper

ESRF dewar

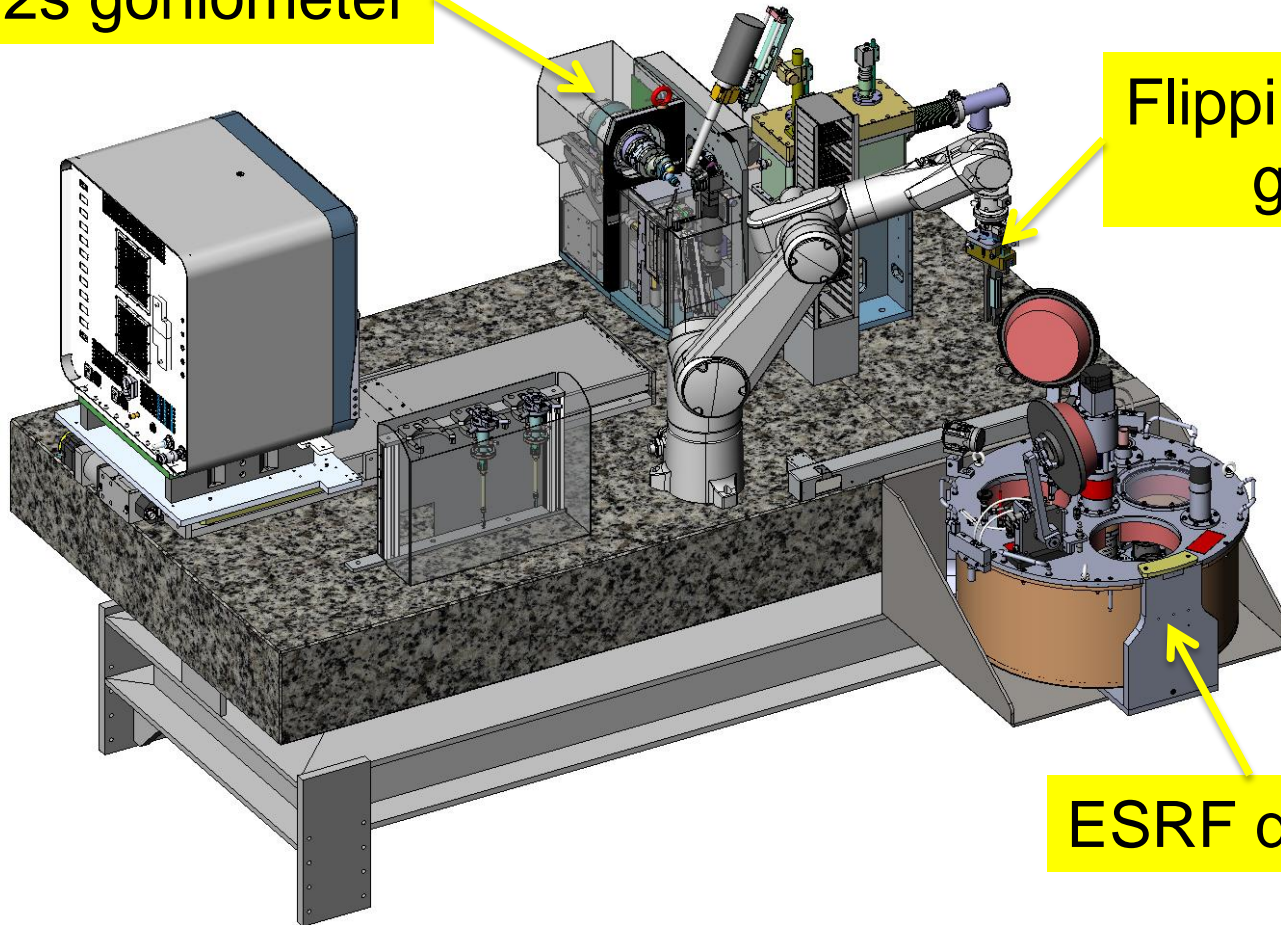

FlexCD – A versatile sample changer

SPINE baskets (x12) = 120 samples

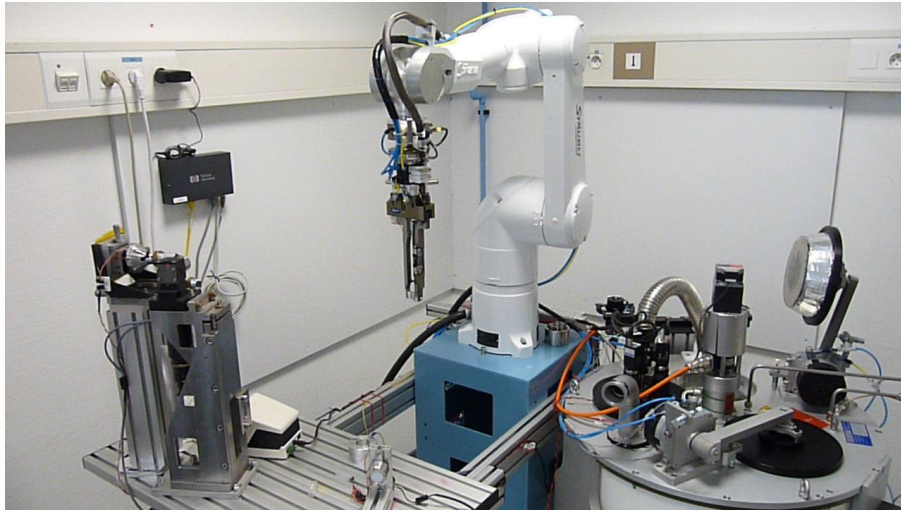

ESRF
SLS
BESSY
PETRAIII
ALBA

Unipucks (x12) = 192 samples



Most US sites

Europe:
DLS
SOLEIL

New sample holder types (36 samples)

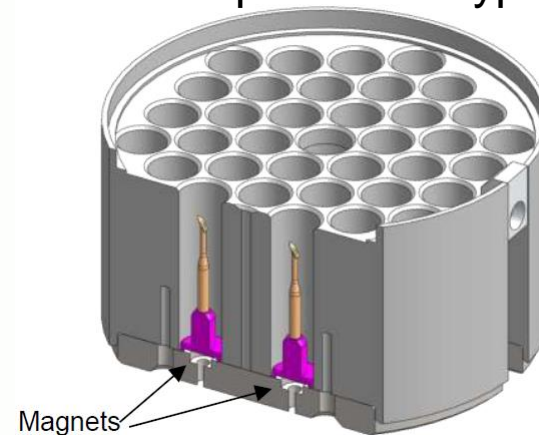

ID30B - Plate screening capability (3Q 2014)

Plate manipulator
nozzle

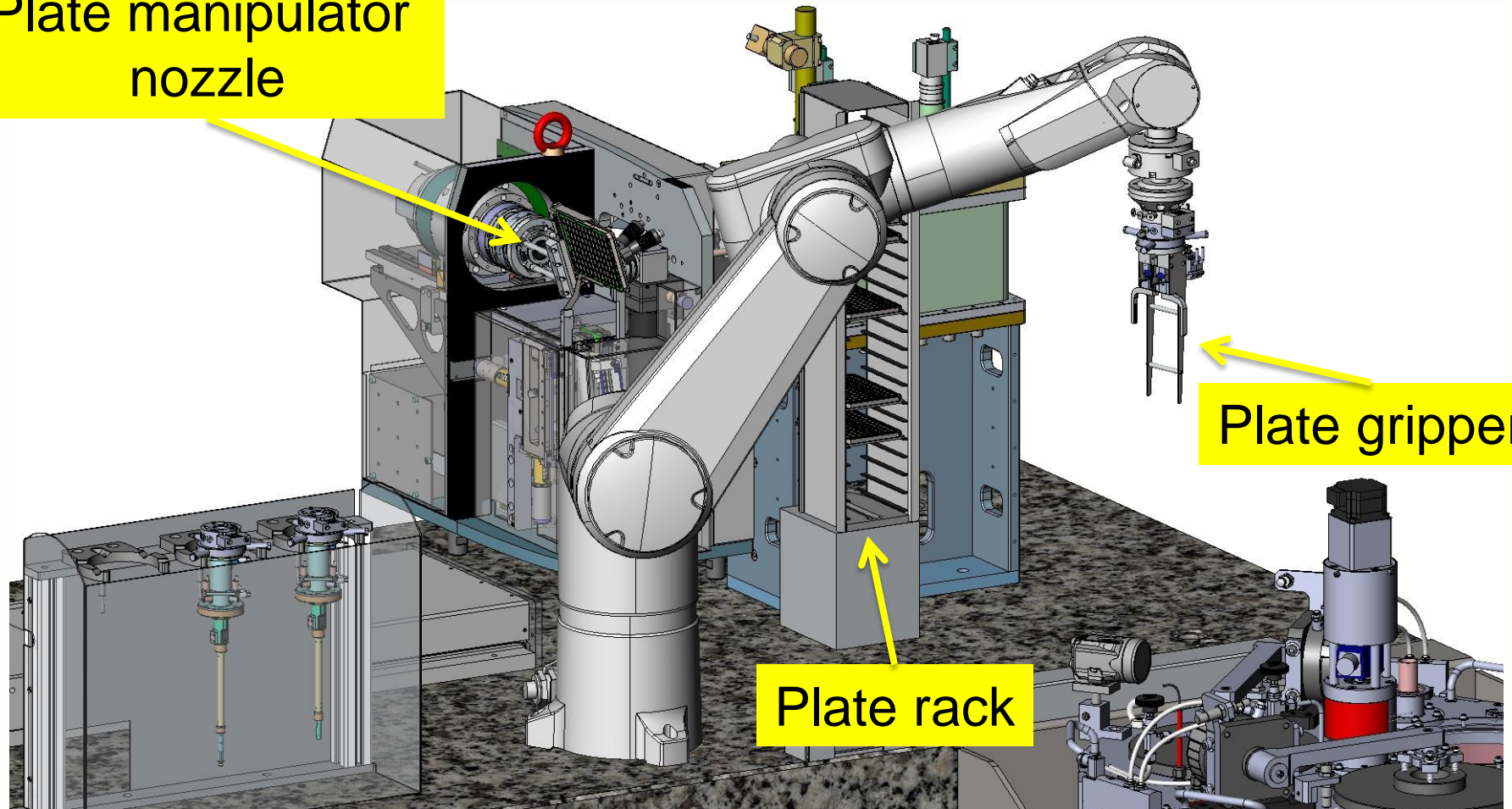

Plate gripper

Plate rack

Acknowledgements

EMBL Grenoble

Stephen Cusack
Regis Legrand

Matthew Bowler
Max Nanao
Hassan Belrhail

Florent Cipriani

Anthony Astruc
Franck Felisaz
Robert Janocha
Christophe Landret
Marcos Lopez-Marrero
Gergely Papp
Christopher Rossi
Jeremy Sinoir
Clement Sorez

ESRF

Jean Susini
Harald Reichert

Gordon Leonard
Christoph Müller-Dieckmann
Philippe Carpentier
Daniele de Sanctis
David Flot
Didier Nurizzo
Pascal Theveneau
Hugo Caserotto
Fabien Dobias
Thierry Giraud
Mario Lentini
Werner Schmid
John Surr
Antonia Beteva
Matias Guijarro

Ray Barrett
Carole Clavel
Thierry Martin
Jean-Michel Georgoux

UVHCI/IBS

Eva Pebay-Peyroula

Sandrine Vignon

Sylvie Costa
Corinne Iodice

